



# GHPC®

Tecnologia em Produtos Pneumáticos

## Cilindro Sem Haste de Arraste Magnético - Série CW

<b>C W</b>		
<b>Modelo</b>		
	<b>Tipos de Guias</b>	<b>Diâmetro (mm)</b>
<b>B</b>	Básico	<b>15</b>
<b>R</b>	Básico com régua lateral	<b>20</b>
<b>S</b>	Guiado com Buchas	<b>25</b>
<b>L</b>	Guiado com Rolamentos	<b>32</b>
		<b>40</b>
	Somente Séries CWB e CWR.	<b>50</b>
		<b>63</b>

	<b>Curso</b>	<b>Amortecedor Hidráulico</b>
	Máx. 2000mm	- Sem Amortecedor
		<b>C</b> Com Amortecedor*

\* Exceto para o modelo básico.

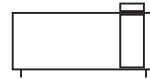

**Exemplo: CWB32-500  
CWS25-100C  
CWL40-200**

Características Técnicas							
<b>Diâmetro (mm)</b>	15	20	25	32	40	50	63
<b>Fluido</b>	Ar						
<b>Pressão de teste (Bar)</b>	10.7						
<b>Pressão máx. de trabalho (Bar)</b>	7						
<b>Pressão mín. de trabalho (Bar)</b>	1.8						
<b>Temp. de trabalho (°C)</b>	-10 ~ 60						
<b>Velocidade (mm/s)</b>	50 à 400						
<b>Amortecimento</b>	Topos elásticos em ambos os lados						
<b>Lubrificação</b>	Não necessária						
<b>Tolerância de curso</b>	0 - 250mm: <sup>+1.0</sup> / <sub>0</sub> , 251 - 1000: <sup>+1.4</sup> / <sub>0</sub> , mais de 1001: <sup>+1.8</sup> / <sub>0</sub>						
<b>Rosca</b>	M5 x 0.8	G 1/8"			G 1/4"		

### Acessórios



Amortecedor	
Rosca	Código
M8 x 1.0	AM-0806
M10 x 1.0	AM-1008
M14 x 1.5	AM-1416
M20 x 1.5	AM-2020
M20 x 1.5	AM-2020

### Gráfico de Força

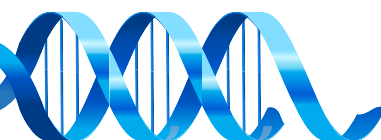
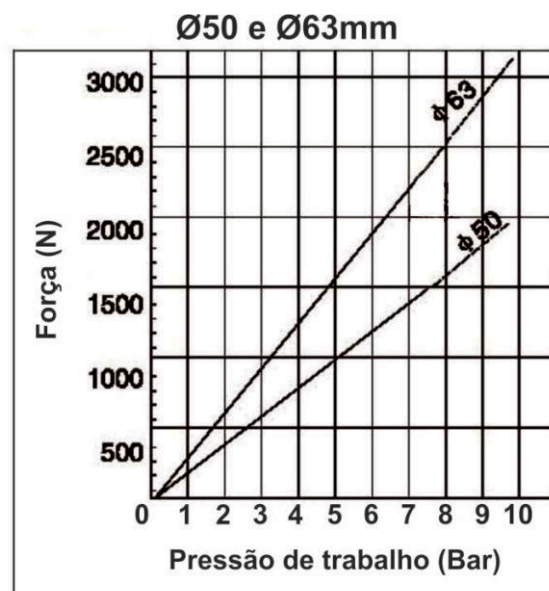
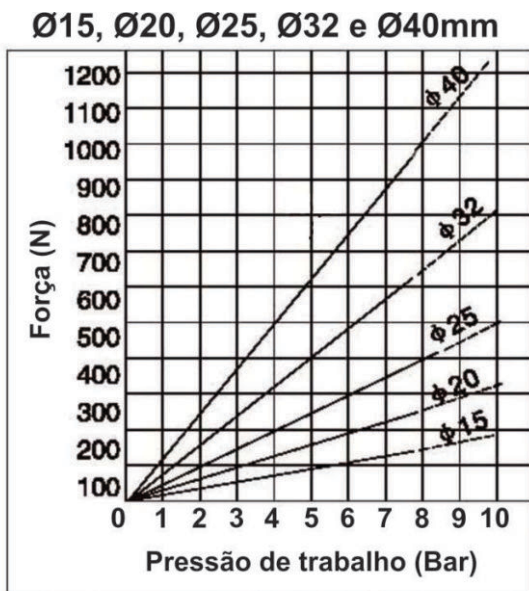

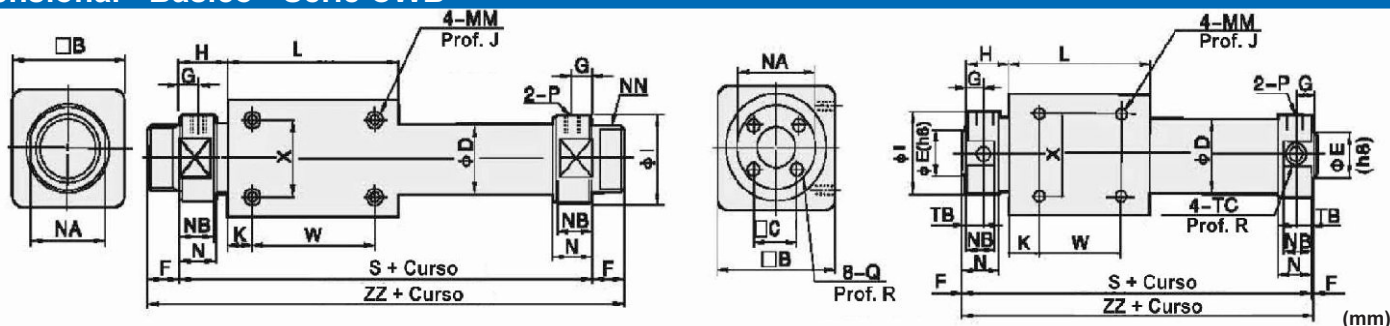
**Cilindro Sem Haste de Arraste Magnético - Série CW**
**Dimensional - Básico - Série CWB**

Diâmetro (mm)	Curso Máx. (mm)	Rosca	ØD	B	C	ØE (h8)	F	G	H	I	K	L
15	1000	M5 x 0.8	17	35	-	-	10	5.5	13	-	11	57
20	2000	G 1/8"	22.8	36	-	-	13	8	20	28	8	66
25	2000	G 1/8"	27.8	46	-	-	13	8	20.5	34	10	70
32	2000	G 1/8"	35	60	-	-	16	9	22	40	15	80
40	2000	G 1/4"	43	70	-	-	16	11	29	50	16	92
50	2000	G 1/4"	53	86	30	30	2	14	33	58.2	25	110
63	2000	G 1/4"	66	100	38	32	2	14	33	72.2	26	122

Diâmetro (mm)	MM x J	N	NA	NB	NN	Q x R	S	TB	TC x R	W	X	ZZ
15	M4 x 0.7 x 6	11	17	-	M10 x 1	-	83	-	-	35	19	103
20	M4 x 0.7 x 6	15	24	13	M20 x 1.5	-	106	-	-	50	25	132
25	M5 x 0.8 x 8	15	30	13	M26 x 1.5	-	111	-	-	50	30	137
32	M6 x 1 x 8	17	36	15	M26 x 1.5	-	124	-	-	50	40	156
40	M6 x 1 x 10	21	46	19	M32 x 2.0	-	150	-	-	60	40	182
50	M8 x 1.25 x 12	25	55	23	-	M8 x 1.25 x 16	176	14	M12 x 1.25 x 7.5	60	60	180
63	M8 x 1.25 x 12	25	69	23	-	M10 x 1.5 x 16	188	14	M14 x 1.5 x 11.5	70	70	192

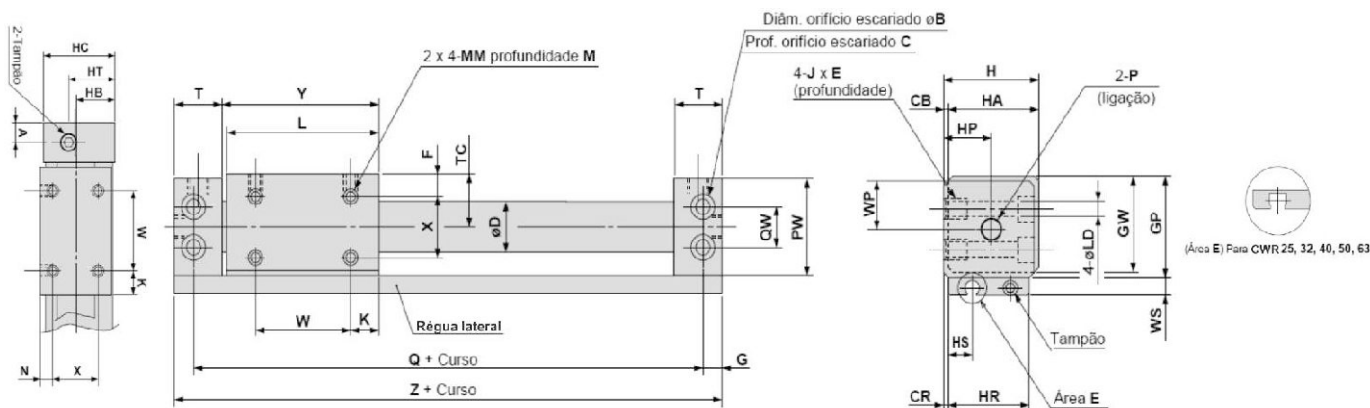
**Dimensional - Básico - Série CWR**

Modelo	A	B	C	CB	CR	D	F	G	GP	GW	H	HA	HB	HC	HP	HR	HS	HT	J x E
CWR15	10.5	8	4.2	2	0.5	17	8	5	33	31.5	32	30	17	31	17	30	8.5	17	M5 x 0.8 x 7
CWR20	9	9.5	5.2	3	1	22.8	9	6	39	37.5	39	36	21	38	24	36	7.5	24	M6 x 1 x 8
CWR25	8.5	9.5	5.2	3	1	27.8	8.5	6	44	42.5	44	41	23.5	43	23.5	41	6.5	23.5	M6 x 1 x 8
CWR32	10.5	11	6.5	3	1.5	35	10.5	7	55	53.5	55	52	29	54	29	51	7	29	M8 x 1.25 x 10
CWR40	10	11	6.5	5	2	43	13	7	65	63.5	67	62	36	66	36	62	8	36	M8 x 1.25 x 10
CWR50	14	14	8.2	5	2	53	17	8.5	83	81.5	85	80	45	84	45	80	9	45	M10 x 1.5 x 15
CWR63	15	14	8.2	5	3	66	18	8.5	95	93.5	97	92	51	96	51	90	9.5	51	M10 x 1.5 x 15

Modelo	K	L	LD	M	MM	N	P	PW	Q	QW	T	TC	W	WP	WS	X	Y	Z
CWR15	14	53	4.3	5	M4 x 0.7	6	M5 x 0.8	32	84	18	19	17	25	16	7	18	54.5	94
CWR20	11	62	5.6	5	M4 x 0.7	7	1/8"	38	95	17	20.5	20	40	19	7	22	64	107
CWR25	15	70	5.6	6	M5 x 0.8	6.5	1/8"	43	105	20	21.5	22.5	40	21.5	7	28	72	117
CWR32	13	76	7	7	M6 x 1	8.5	1/8"	54	116	26	24	28	50	27	7	35	79	130
CWR40	15	90	7	8	M6 x 1	11	1/4"	64	134	34	26	33	60	32	7	40	93	148
CWR50	25	110	8.6	10	M8 x 1.25	15	1/4"	82	159	48	30	42	60	41	10	50	113	176
CWR63	24	118	8.6	10	M8 x 1.25	16	1/4"	94	171	60	32	48	70	47	10	60	121	188

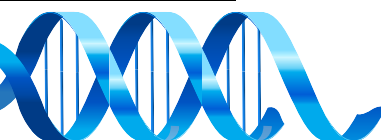



# GHPC®

Tecnologia em Produtos Pneumáticos

## Cilindro Sem Haste de Arraste Magnético - Série CW

### Dimensional - Guiado com buchas - Série CWS

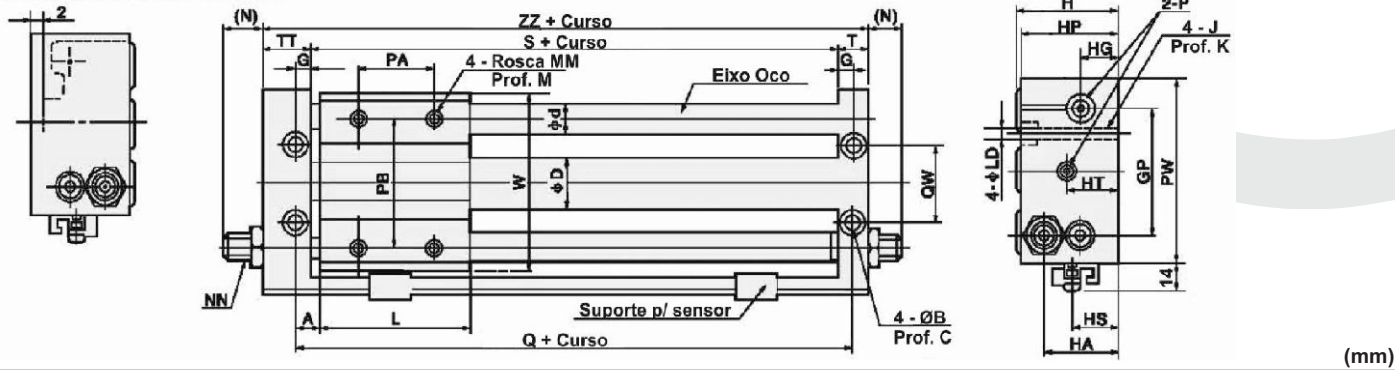

(mm)

Diâmetro (mm)	Curso Máx. (mm)	ØD	Ød	A	ØB	C	HT	G	GP	H	HA	HG	HP	HS	T	J x K	L
15	750	16.6	12	7.5	9.5	5	21	6.5	52	40	29	13	39	15	12.5	M6 X 1 X 9.5	60
20	1500	21.6	16	10	9.5	5.2	20	8.5	62	46	36	17	45	25.5	16.5	M6 X 1 X 9.5	70
25	1500	26.4	16	10	11	6.5	20	8.5	70	54	40	20	53	23	16.5	M8 X 1.25 X 15	70
32	1500	33.6	20	12.5	14	8	24	9.5	86	66	46	24	64	27	18.5	M10 X 1.5 X 15	85
40	1500	41.6	25	12.5	14	8	25	10.5	104	76	57	25	74	30	20.5	M10 X 1.5 X 15	95

Diâmetro (mm)	LD	M	MM	NN	(N)	P	PA	PB	PW	QW	Q	S	TT	Z	W
15	5.6	8	M5 X 0.8	M8 X 1	7.5	M8 X 0.8	30	50	75	30	75	62	22.5	97	72
20	5.6	10	M6 X 1	M10 X 1	9.5	G 1/8"	40	70	90	38	90	73	25.5	115	87
25	7	10	M6 X 1	M14 X 1.5	11	G 1/8"	40	70	100	42	90	73	25.5	115	97
32	8.7	12	M8 X 1.25	M20 X 1.5	11.5	G 1/8"	40	75	122	50	110	91	28.5	138	119
40	8.7	12	M8 X 1.25	M20 X 1.5	10.5	G 1/8"	65	105	145	64	120	99	35.5	155	142

### Dimensional - Guiado com rolamentos - Série CWL

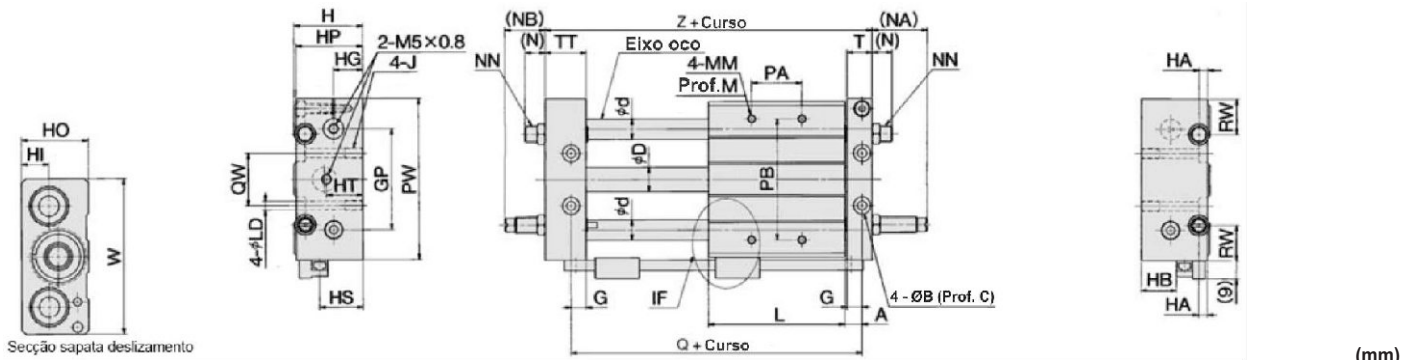

Seção sapata deslizamento

(mm)

Modelo	A	B	C	ØD	Ød	G	GP	H	HA	HB	HG	HI	HO	HP	HT	J	JK	L	LD
CWL15	7.5	9.5	5	16.6	12	6.5	65	40	6.5	4	16	14	38	39	16	M6 x 1.0	9.5	75	5.6
CWL20	9.5	9.5	5.2	21.6	16	8.5	80	46	9	10	18	16	44	45	20	M6 x 1.0	10	86	5.6
CWL25	9.5	11	6.5	26.4	16	8.5	90	54	9	18	23	21	52	53	20	M8 x 1.25	10	86	7
CWL32	10.5	14	8	33.6	20	9.5	110	66	12	26.5	26.5	24.5	64	64	25	M10 x 1.5	15	100	9.2
CWL40	11.5	14	8	41.6	25	10.5	130	78	12	35	30.5	28.5	76	74	30	M10 x 1.5	15	136	9.2

Modelo	M	MM	(N)	(NA)	(NB)	NN	P	PA*	PB	PW	Q	QW	RW	T	TT	W	Z
CWL15	8	M5 x 0.8	7.5	27	17	M8 x 1.0	M5 x 0.8	45	70	95	90	30	15	12.5	22.5	92	112
CWL20	10	M6 x 1.0	10	29	20	M10 x 1.0	1/8"	50	90	120	105	40	28	16.5	25.5	117	130
CWL25	10	M6 x 1.0	11	49	40	M14 x 1.5	1/8"	60	100	130	105	50	22	16.5	25.5	127	130
CWL32	12	M8 x 1.25	11.5	52	42	M20 x 1.5	1/8"	70	120	160	121	60	33	18.5	28.5	157	149
CWL40	12	M8 x 1.25	10.5	51	36	M20 x 1.5	1/4"	90	140	190	159	84	34	20.5	35.5	187	194

\* As dimensões PA estão centradas em relação a L.

